

MOSS **EZ FABRIC WALL**™

PATENTED MODULAR WALL SYSTEMS

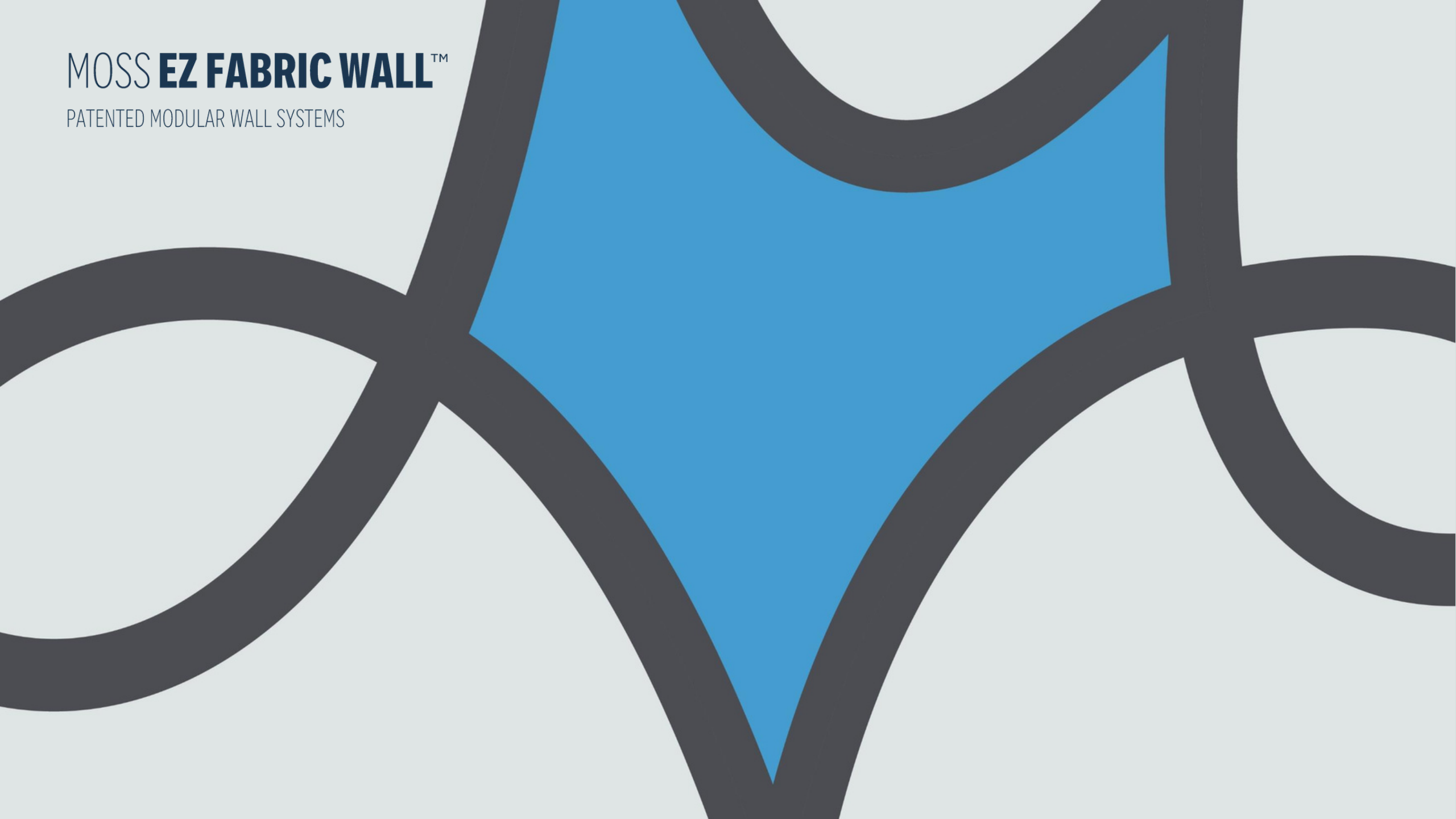

MOSS EZ FABRIC WALL™

EZ Fabric Wall™ and EZ Fabric Wall™ II are patented modular wall systems that combine the versatility of modular walls with the benefits of lightweight fabric. Flexible to your intended vision, adaptable to your needs.

Create:

- **Complete in-line and island booths**
- **Unique towers**
- **Back walls**
- **Conference rooms**
- **Entire exhibits, and more**

Available for purchase (EZ Fabric Wall™)

or rental (EZ Fabric Wall™ and EZ Fabric Wall™ II)

Designed around a 39" W x 93" H wall with half width, half height, entry header, and curved variations available.

Works with Moss Classic™ Shapes, Rents™, Moss Groove™ and Construct™ lines, and with your own custom structures.



THE POSSIBILITIES ARE ENDLESS TO CREATE YOUR OWN DESIGN

Microsoft Azure Media Services Scalable Cloud Video Solutions

Live Streaming

Live and VOD
Media Delivery
at Scale
Rich Content
Monetization
Supports Flash,
iOS, Android,
Windows, Xbox
and MPEG-DASH



Multi-Screen Video



Studio Certified
DRM Support
Highly Available
Encoding and
Streaming
Broad
Ecosystem of
Pre-Integrated
Partners



Transforming Media with Cloud and Devices



Thank you to our booth partners:



EZ FABRIC WALL™ FEATURES

- Portable, modular wall system
- Lightweight, inexpensive to ship
- Easy and fast to set up
- Versatile – can use fabric graphics or 3mm rigid Sintra panels
- Can easily be integrated with existing/other systems
- Can easily be integrated with other Moss product lines
- Modular frames assemble with use of connection hardware
- Competitively priced
- Additional unique accessories available for frame/structure enhancement



EZ FABRIC WALL™ II **UPGRADES**

- EZ Fabric Wall™ II is compatible with original EZ Fabric Wall™ Frames
- New panels install in both directions while maintaining extrusion strength
- New doors: ADA door, Acrylic Door option for Graphic Door (*coming soon*)
- Notches in frame corners allow for continuous SEG
- Round holes on sides for wire access, base plates, and moveable locks



3 WAYS TO **UPGRADE**

TRY BEFORE YOU BUY

- Purchase Moveable Locks and Lock in Bumper Feet to upgrade current stock
- Rent new sizes from Moss as needed

PURCHASE NEW SIZES

- Purchase stock of EZ Fabric Wall™ II new sizes with moveable locks to offer the highest level of design flexibility*

REPLACE ALL STOCK

- If your existing stock is on its last legs, you may want to upgrade
- You can purchase new stock of EZ Fabric Wall™ II components to offer the highest level of design flexibility*

**Purchase option available soon*



MOSS EZ FABRIC WALL™

- Lightweight, compact, and easy to assemble with a single tool – saves on installation and shipping costs
- Exclusive tension locks connect walls in seconds
- Illuminedge™ EZ Walls combine standout brilliance with plug-and-play simplicity
- Custom-printed fabric can span multiple wall sections using patented technology
- System is reusable and contributes to sustainability. Combined with our full line of [sustainable materials](#), EZ Fabric Wall™ II provides one of the most sustainable solutions on the market

View product [video here](#).

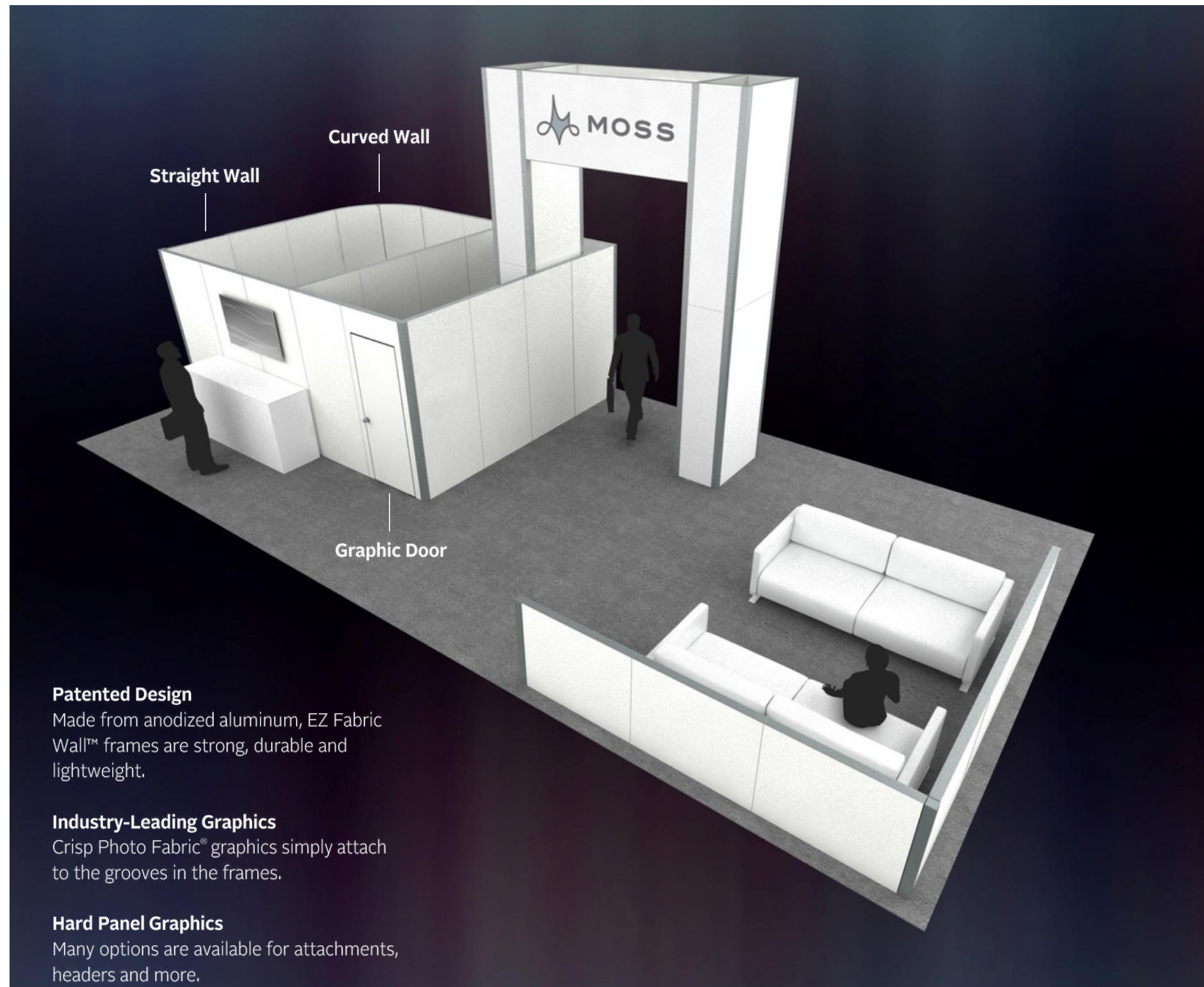

STRAIGHT WALL FRAMES

Turn any amount of floor space into a showcase with designed walls.

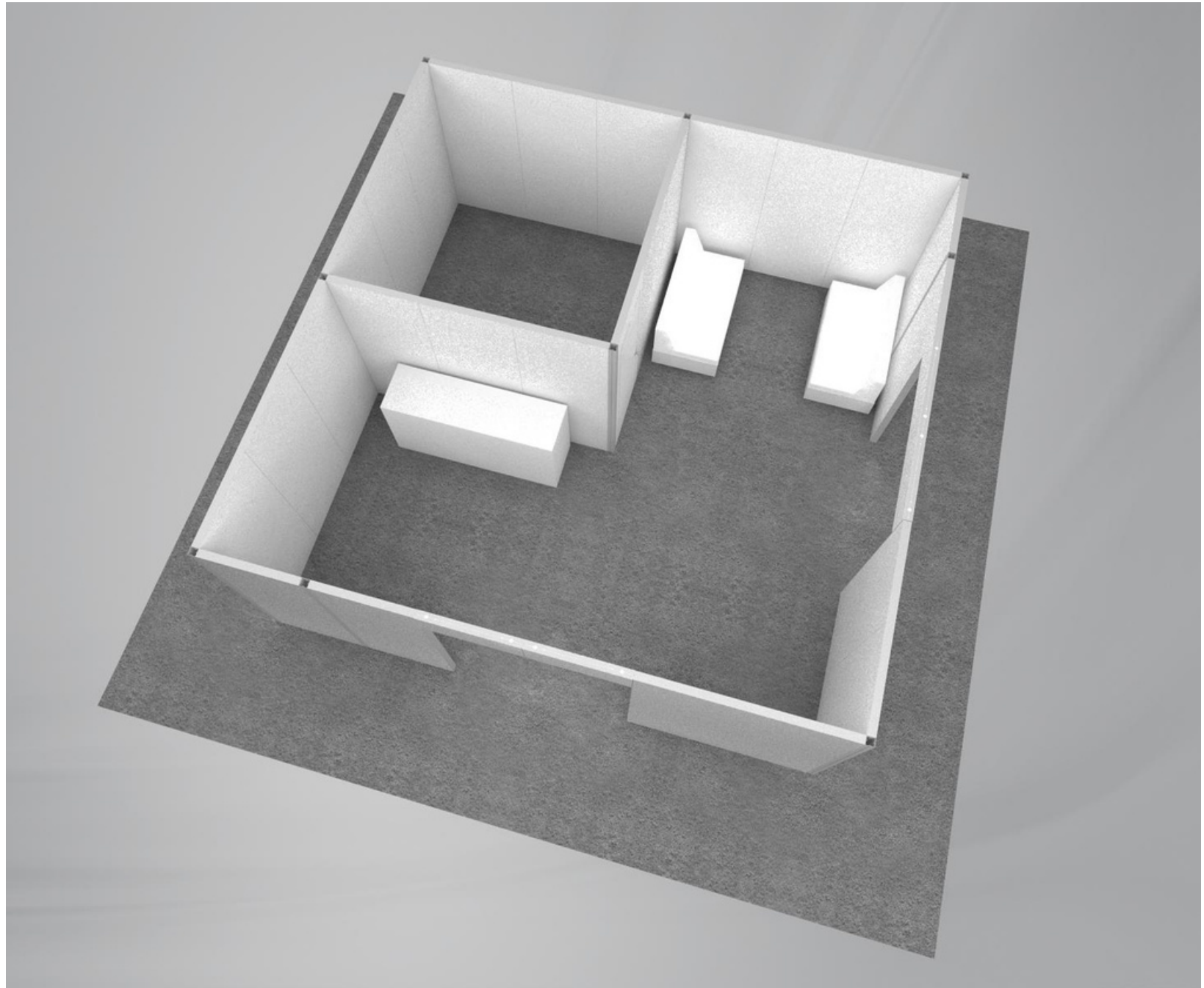

CURVED WALL FRAMES

Add interest to your space with curved walls. With a variety of widths and heights, the walls can be configured to make the most of any display space.

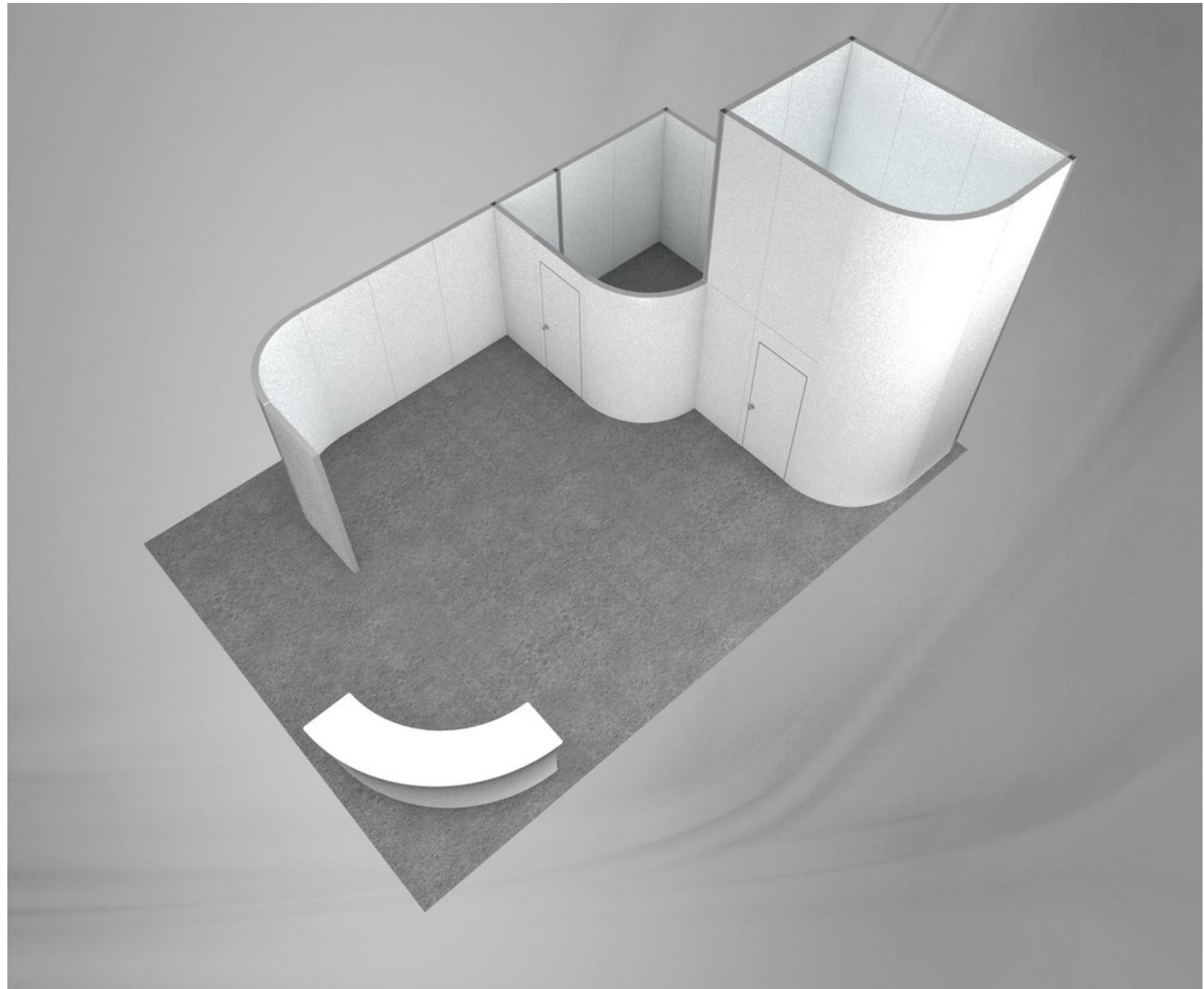

STANDARD **EZ WALLS**

- Standardized wall sizes and modular functionality allow for quick frame assembly that incorporates accessories and lighting
- All frames are made of 80mm aluminum extrusion with a clear anodized finish
- All frames are double-sided
- 8 Movable Locks are included with each frame and with assembly using Torx Tool included
- Frames hold SEG Graphic Fabric Panels
- Wire management holes on all 4 sides
- Optional Velcro Liners available
- Weight: 1.010 lbs/ft



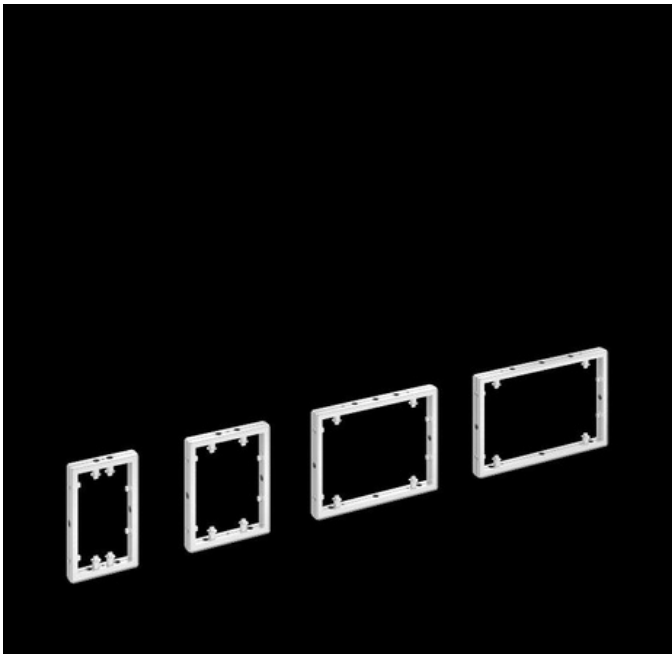

24" EZ FABRIC WALL™ II

Sizes:

- 15"w x 24"h
- 19.5"w x 24"h
- 32.5"w x 24"h
- 39"w x 24"h

Frame:

Welded Anodized Aluminum

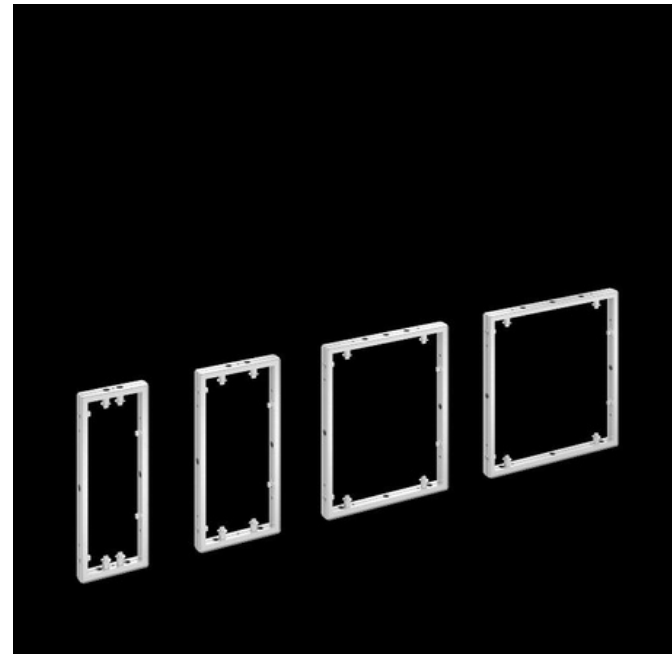

39" EZ FABRIC WALL™ II

Sizes:

- 15"w x 39"h
- 19.5"w x 39"h
- 32.5"w x 39"h
- 39"w x 39"h

Frame:

Welded Anodized Aluminum

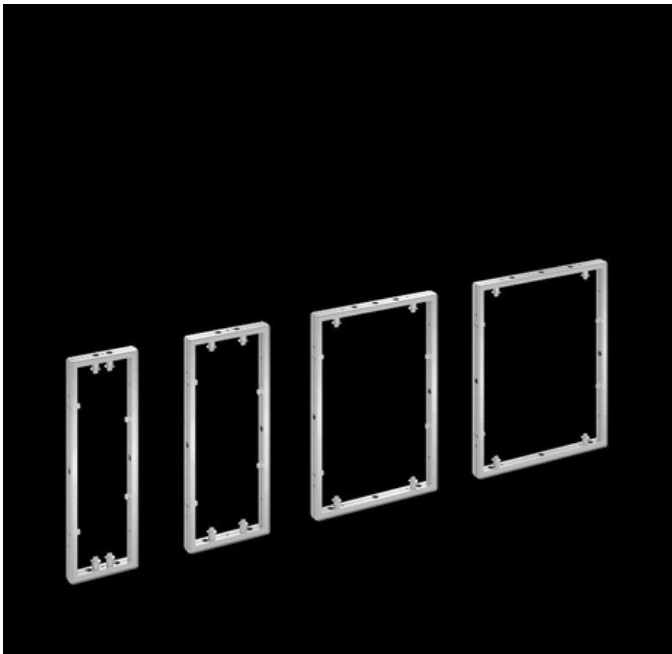

46.5" EZ FABRIC WALL™ II

Sizes:

- 15"w x 46.5"h
- 19.5"w x 46.5"h
- 32.5"w x 46.5"h
- 39"w x 46.5"h

Frame:

Welded Anodized Aluminum

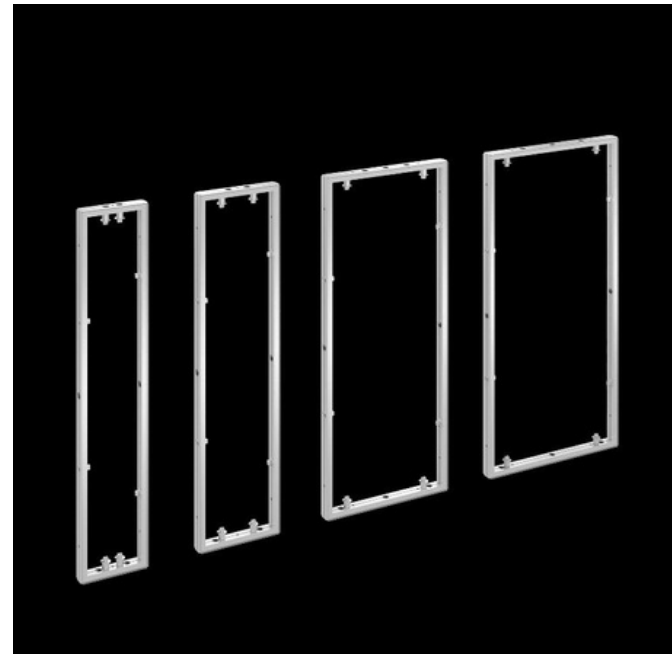

78" EZ FABRIC WALL™ II

Sizes:

- 15"w x 78"h
- 19.5"w x 78"h
- 32.5"w x 78"h
- 39"w x 78"h

Frame:

Welded Anodized Aluminum

93" EZ FABRIC WALL™ II

Sizes:

15"w x 93"h
19.5"w x 93"h
32.5"w x 93"h
39"w x 93"h

Frame:

Welded Anodized Aluminum

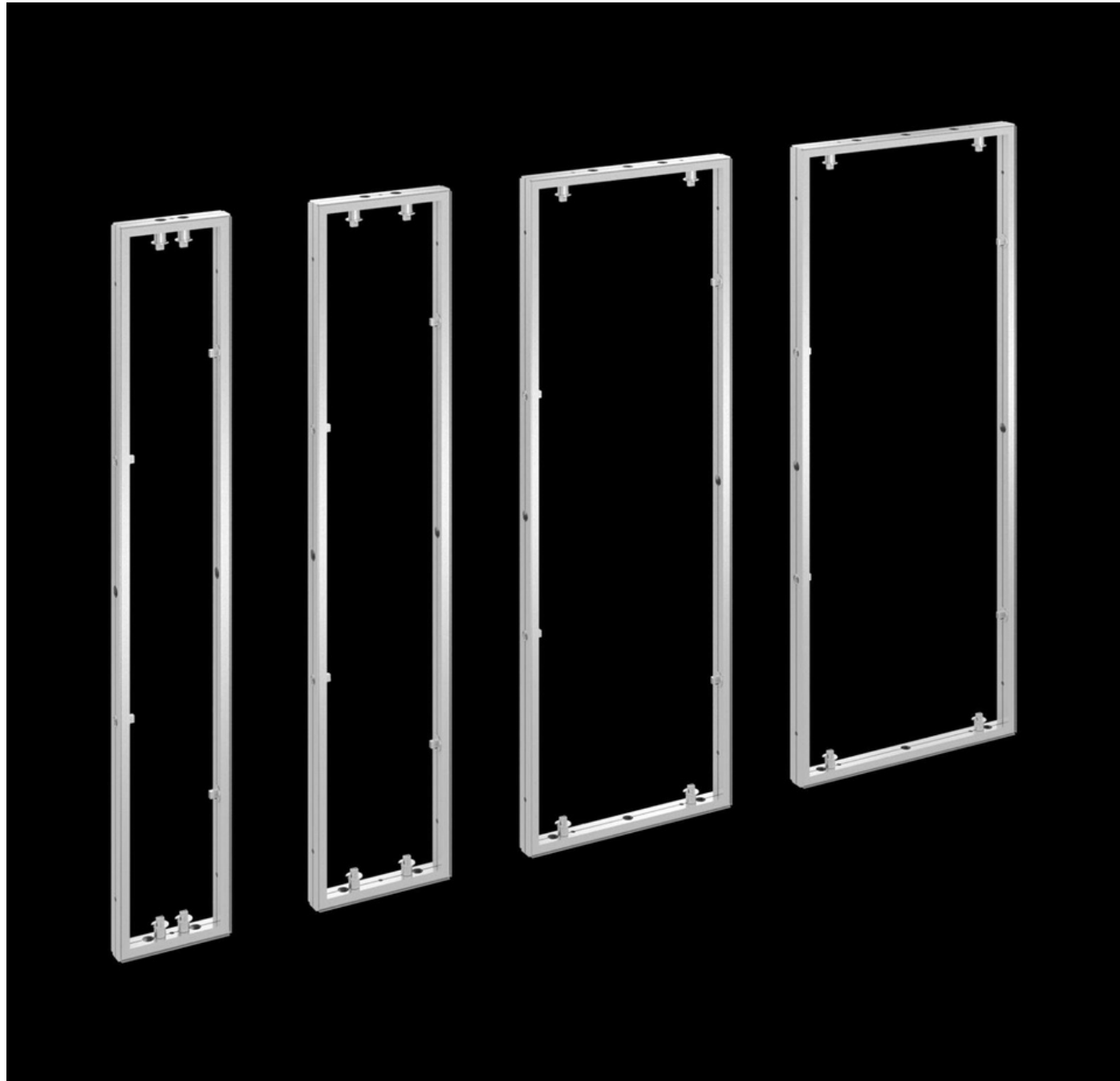

SINGLE PANEL GRAPHICS

All EZ Fabric Wall™ modular panels accept graphic covers

Covers can be either fabric or rigid panels

Breaks are visible between frames when stood next to each other

MULTI-WALL GRAPHICS

EZ Fabric Wall™ custom graphic options are available

A single fabric cover spans over multiple EZ Fabric Wall frames, creating a completely bezel-free look

Notches at break points where each panel meet are no longer needed with EZ Fabric Wall™ II

Multi-wall covers can only be fabric

ACCESSORY COLUMNS

- Use modular accessory columns to create towers and special spaces
- All columns are 80mm anodized aluminum

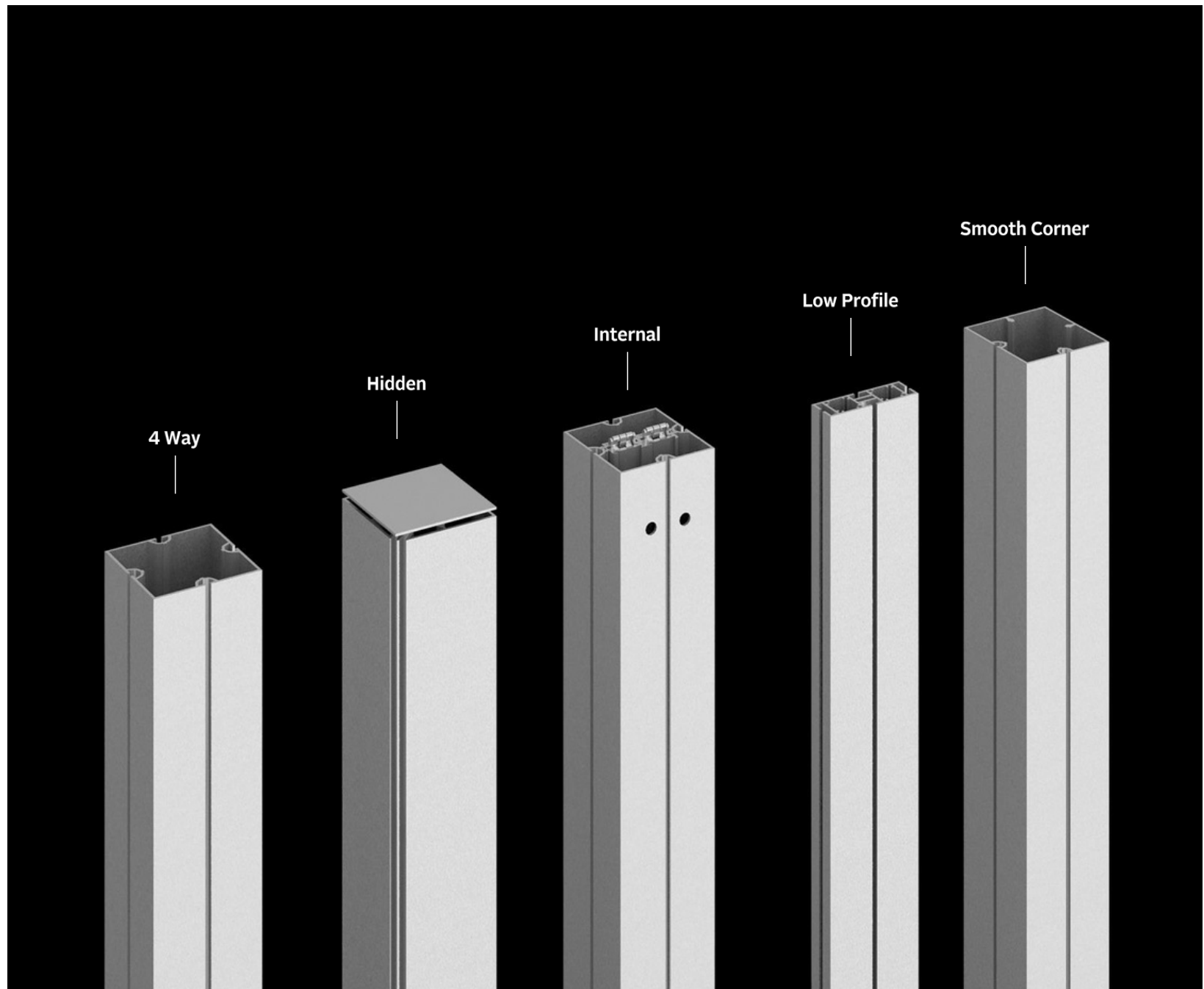

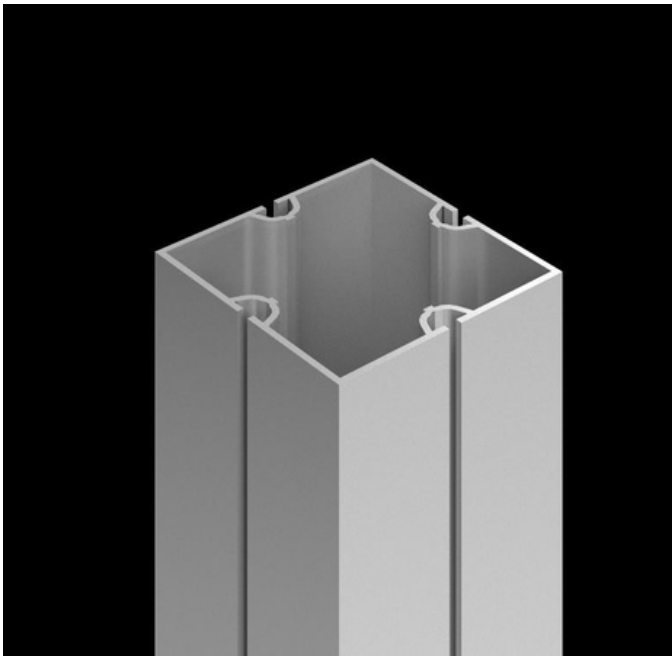

4 WAY CORNER COLUMN

Create 90° corners between walls,
hide structure columns with graphics

Clean uniformed look with gasket
fabric edges at the corner points

Heights Available:

- 93"
- 78"
- 46.50"
- 39"
- 32.50"
- 24"
- 19.50"
- 15"

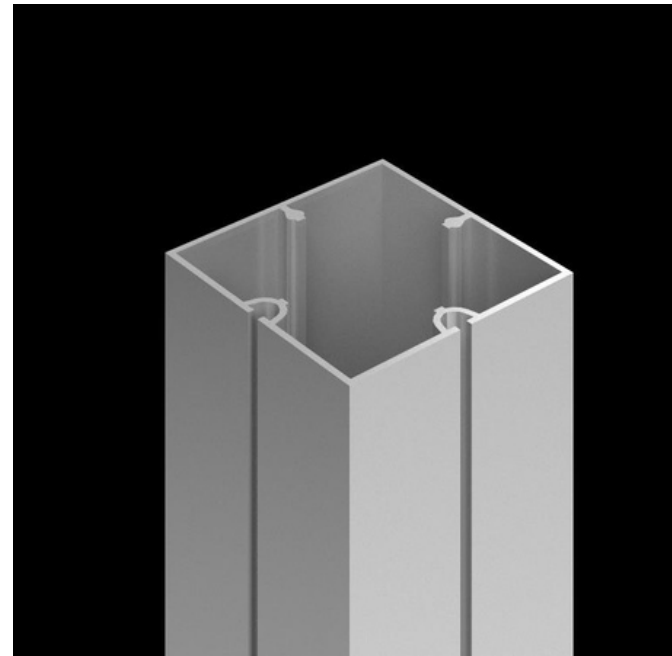
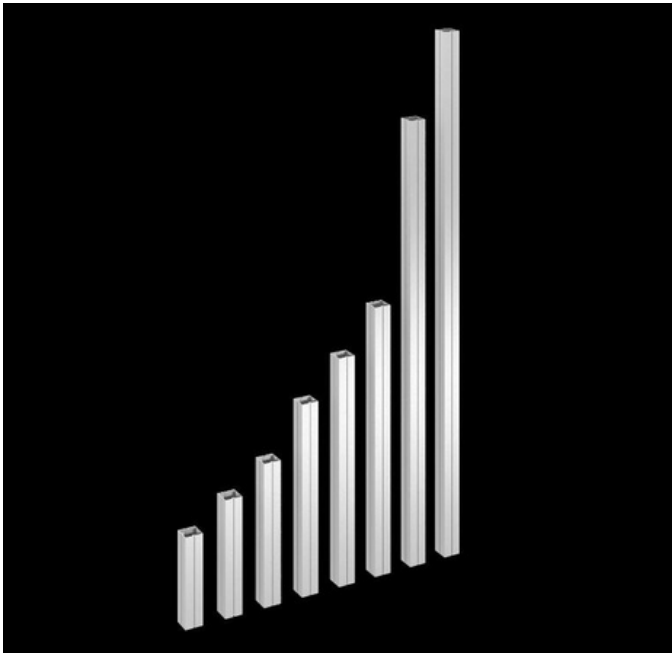

SMOOTH CORNER COLUMN

Creates 90° corners between walls
with two smooth faces

Channel on only two faces

Heights Available:

- 93"
- 78"
- 46.50"
- 39"
- 32.50"
- 24"
- 19.50"
- 15"

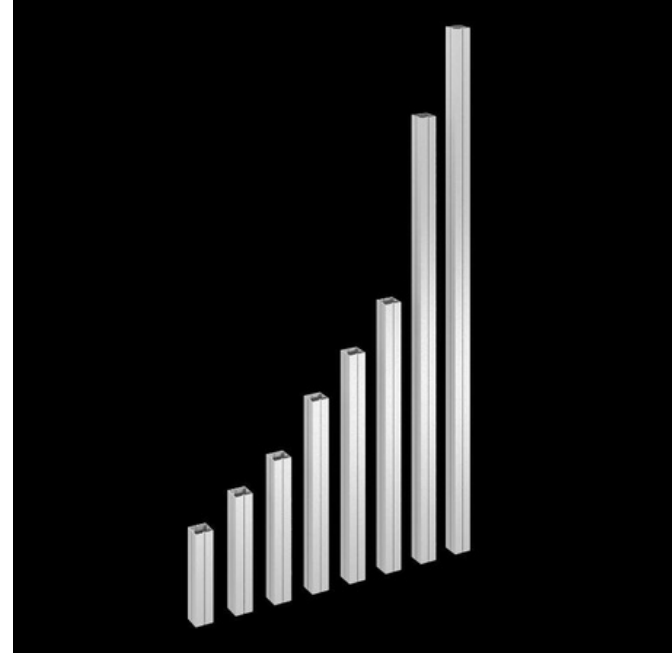

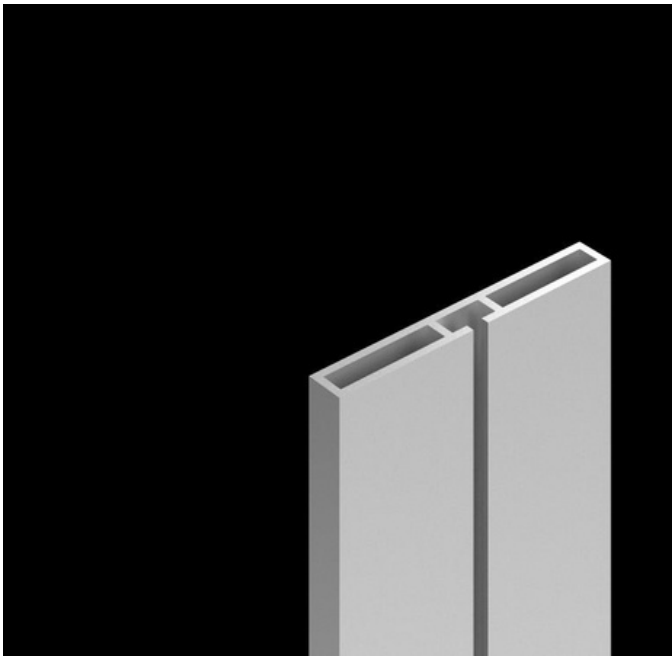

END CAP COLUMN

Use to cap the ends of the EZ Fabric Wall™ frame panels for a smooth surface finish

Use along the top of your pony walls for a smooth finish

Heights Available:

93"
78"
46.50"
39"
32.50"
24"
19.50"
15"

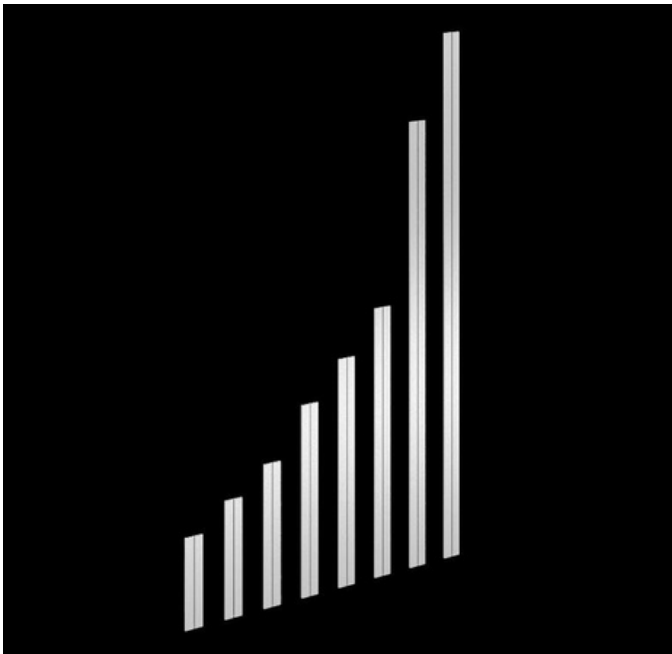

HIDDEN CAP COLUMN

Creates 90° corners between walls to hide structural columns with graphics

Clean, uniform look with gasketed fabric edges at corner points

Can be used with 80 mm Moss Groove

Heights Available:

93"
78"
46.50"
39"
32.50"
24"
19.50"
15"

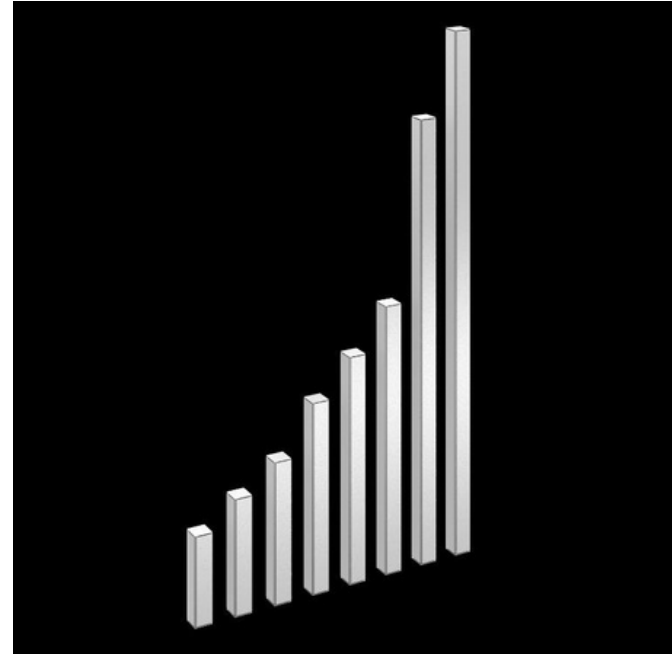

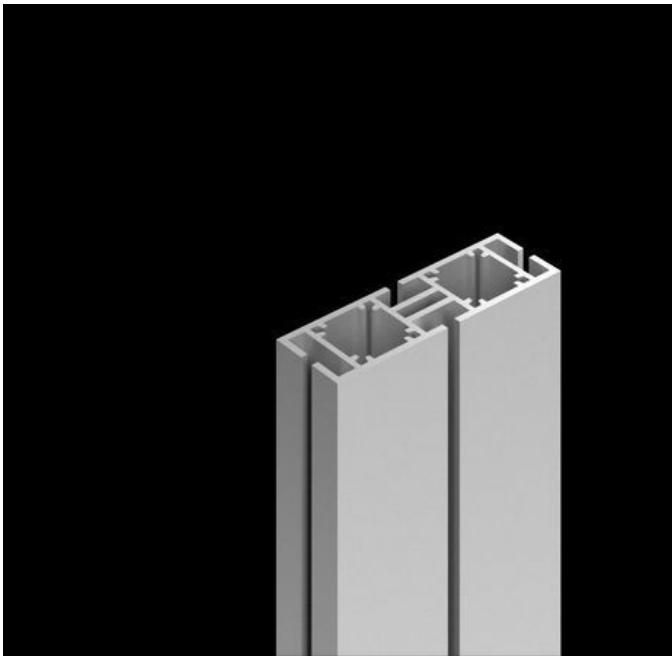

LOW PROFILE COLUMN

Provide accessory attachment locations between walls

Channel on all 4 sides for multiple configurations

Heights Available:

93"
78"
46.50"
39"
32.50"
24"
19.50"
15"

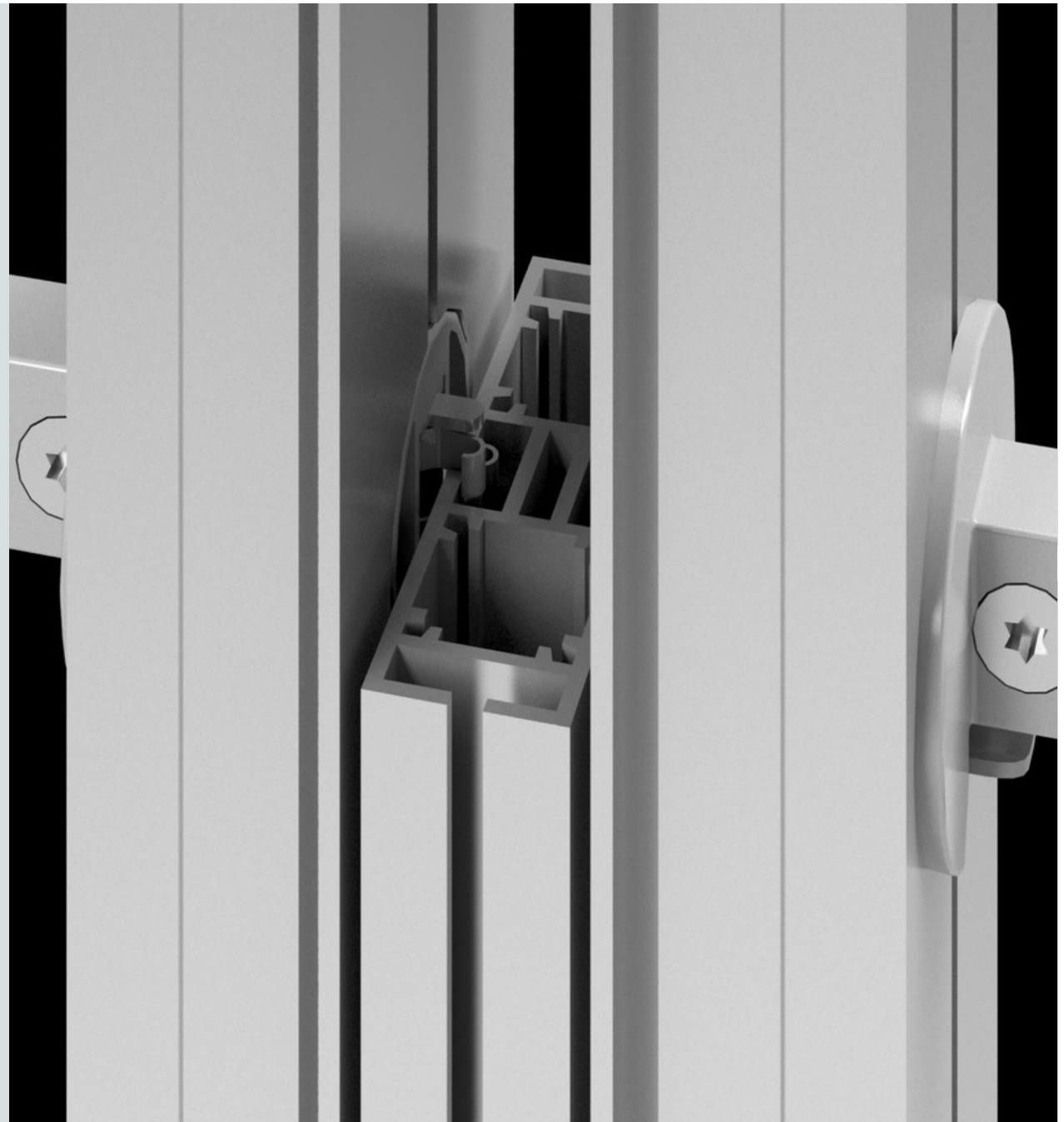
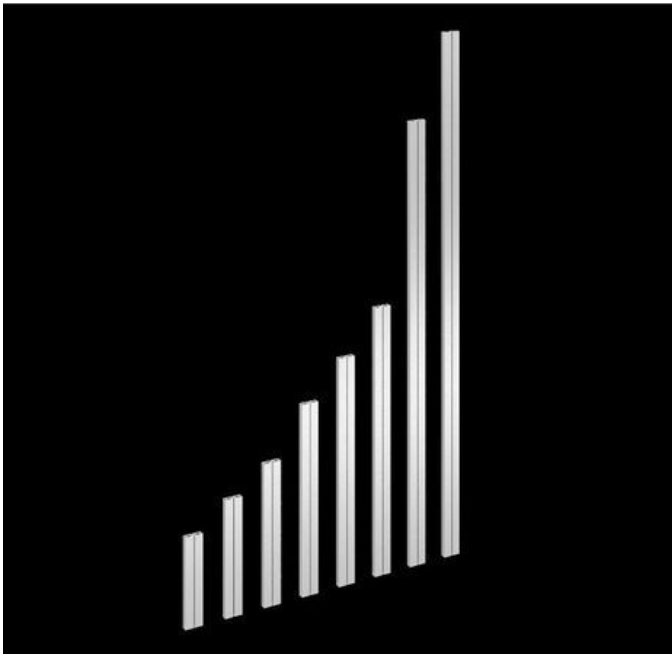

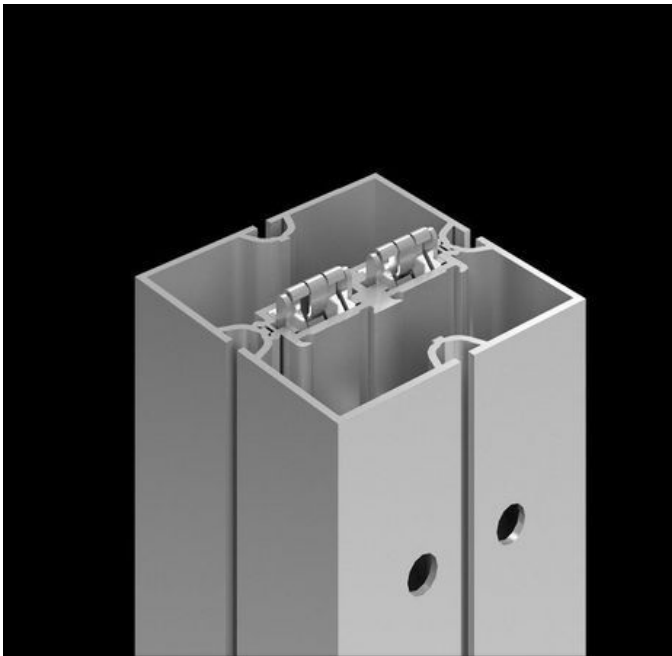

INTERNAL COLUMN

Install into a wall to provide accessory mounting locations

Heights Available:
93"
39"
46.50"

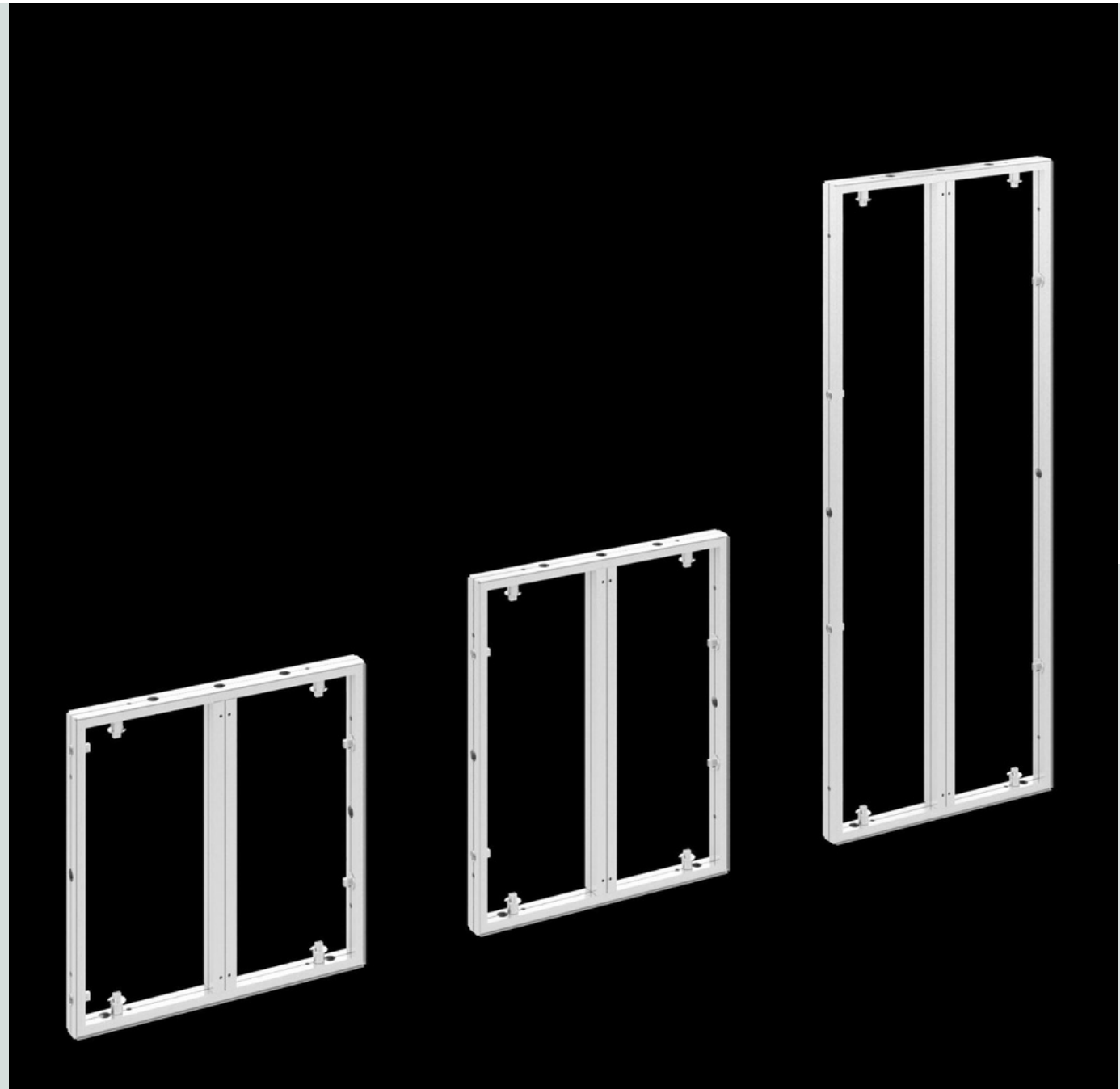

MOVEABLE LOCKS

INCLUDED WITH FRAME OR ORDERED AS AN ACCESSORY

- 8 Moveable Locks ship with each EZ Fabric Wall™ II Frame
- Locks snap into the frame for very fast install and use the same ultra-strong lock and extrusion that provides the stability EZ Fabric Wall™ is known for
- Moveable Locks store in lock holes or can lock into the interior system groove when not in use. This allows your locks to always remain with your panel, even when they are not needed for a specific install
- Moveable Locks are sold in kits of 20 pcs
- 4 Moveable Locks and 2 Lock in Bumper Feet are needed to upgrade 1 original EZ Fabric Wall™ frame to install in both directions

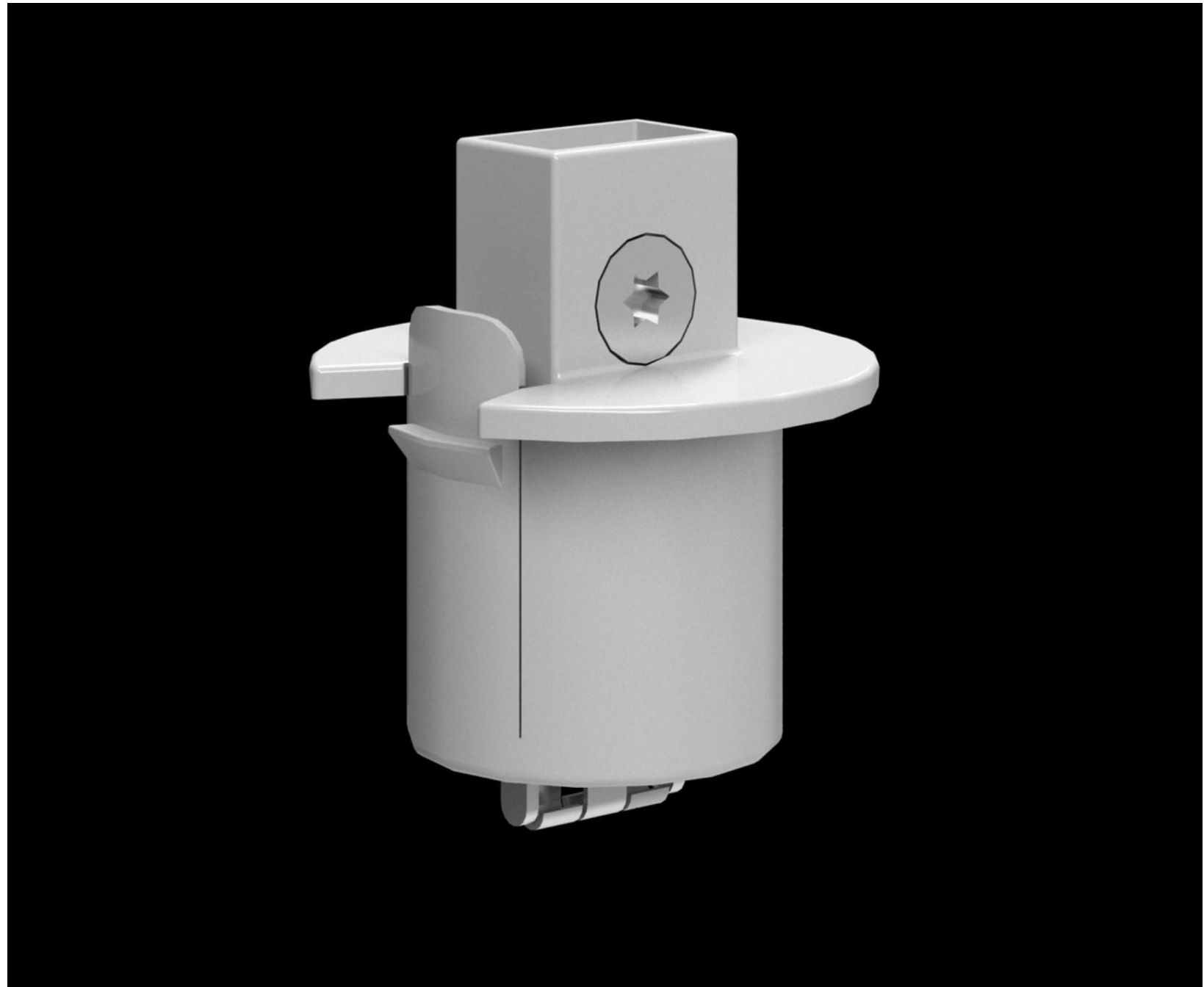

ACCESSORY **BUMPER FEET**

- Ideal for raising EZ Fabric Wall™ II panels off the ground slightly
- Lock in Bumper Foot is needed for original EZ Fabric Wall™ panels
- Snap in Bumper Foot is optional for EZ Fabric Wall™ II panels

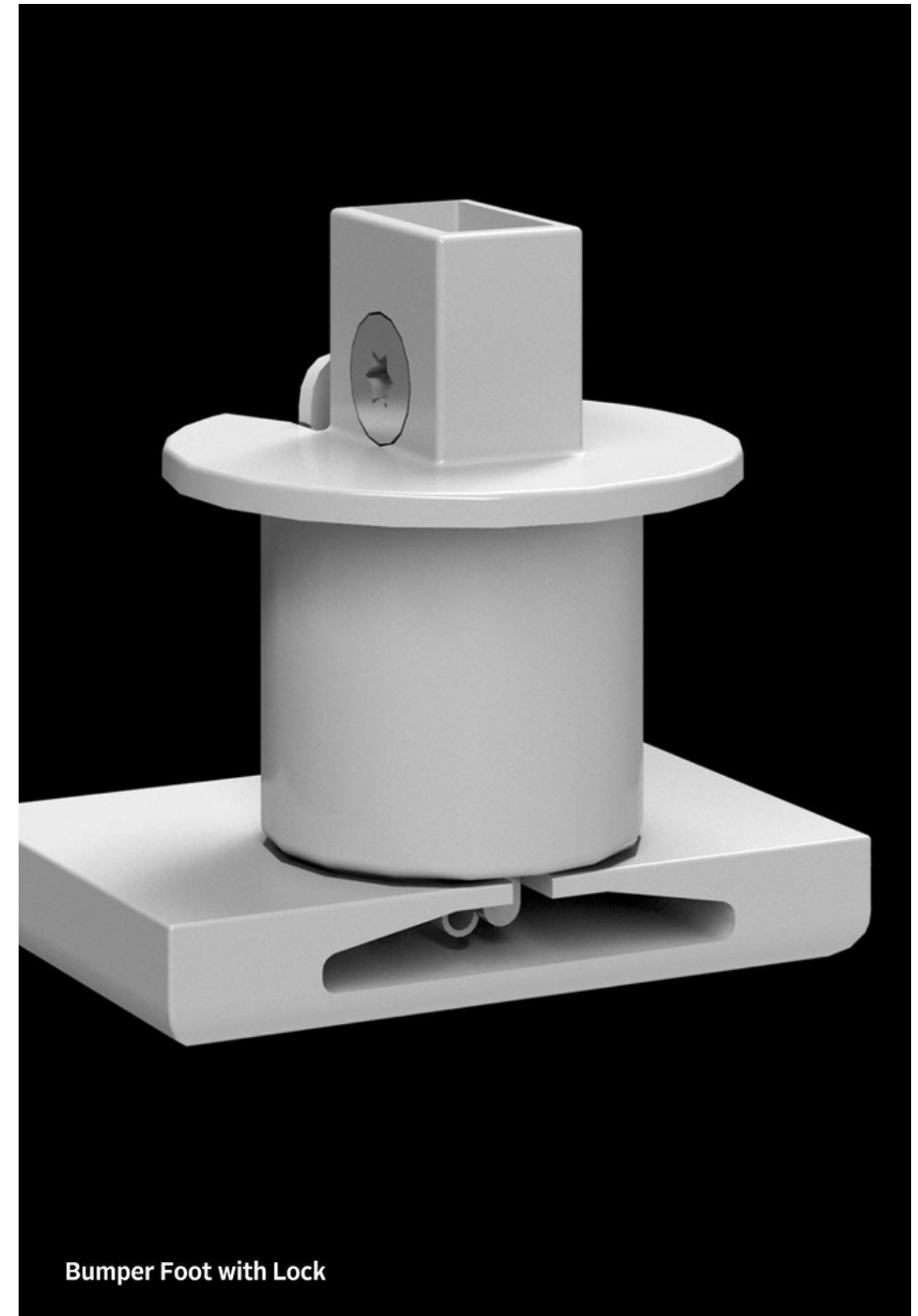
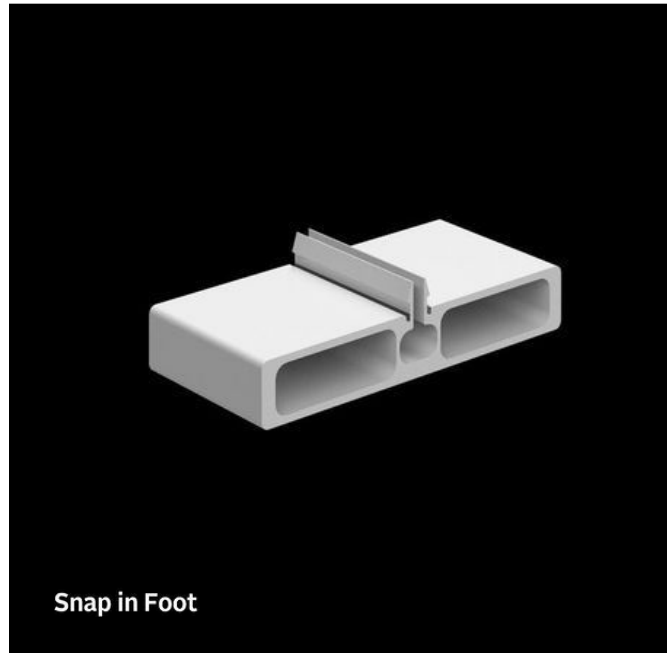

GRAPHIC DOOR

ADA DOORS

- Moss ADA doors meet or exceed ADA requirements with a 34" opening, 1/2" rounded threshold, 3 second close time at 90 , 12" solid surface at bottom for push open, comes with a lever handle

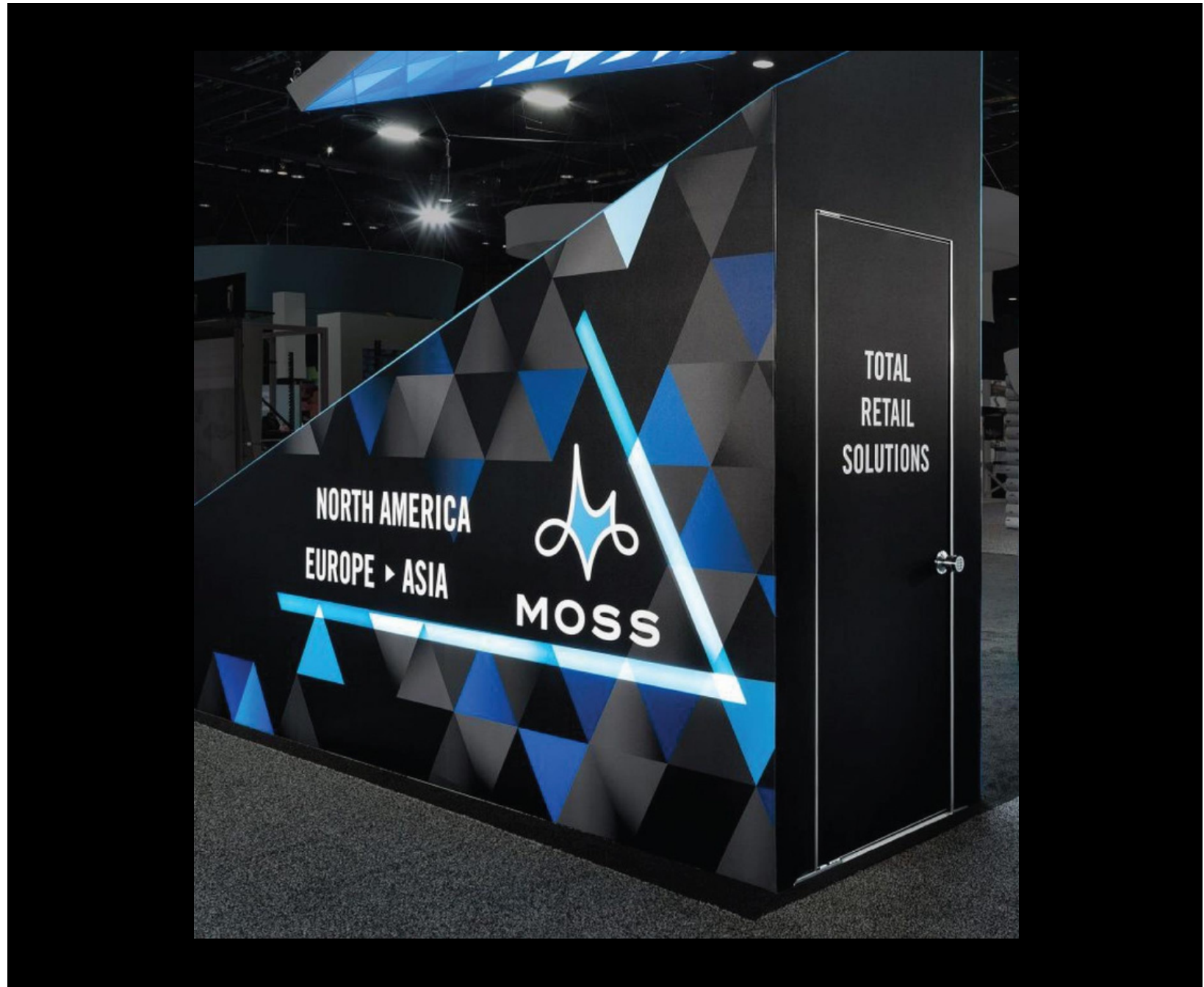

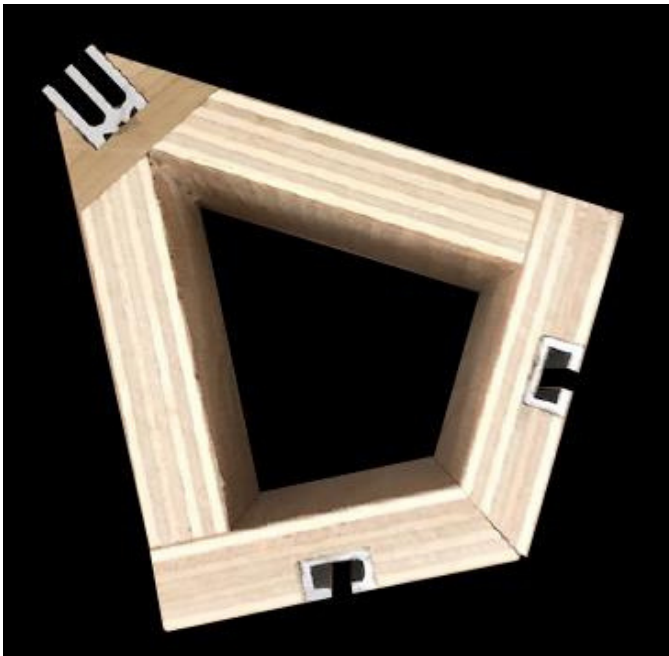

CUSTOM CORNER

Built to order wood fabrication with an extrusion inset

Allows for a fully covered corner instead of exposed metal and the best quality fabric installation



WALL STACKING CONNECTOR

Stack EZ Fabric Walls up to two stories high

Sold in packs of 2; two connectors must be used for every stacked wall



RIGID CLAMP

Attaches rigid materials 4mm – 10mm thick to an accessory column

Use in horizontal or vertical orientation or angles in between



UNIVERSAL ATTACHMENT PLATE

Attaches EZ Fabric Walls to hard panels

Groove for locking walls

Can be recessed in milled pocket in wood to create a flush connection

Sold in packs of 4; bolts not included

CONTACT **MOSS**

**FRANKLIN PARK, ILLINOIS
GLOBAL HEADQUARTERS**
10501 Seymour Ave., Suite #200
Franklin Park, IL 60131
USA
800.341.1557

LENNESTADT, GERMANY
Wigeystraße 18 – 20
57368 Lennestadt, Germany
+49 2723 96680

POZNAN, POLAND
Poznańska 38
62-020 Jasin, Poland
+48 (0) 608-415 847

www.mossinc.com



MOSS

THE ULTIMATE
PARTNERSHIP
EXPERIENCE